



Polly Wog as built by A. Forster.

## Polly Wog

Here's a sturdy outboard utility boat whose speed will really surprise you

By WILLIAM D. JACKSON

Naval Architect

Craft Print Project No. 152

**H**ERE is a planing-type, outboard utility boat that is unusually fast. Though quite maneuverable at higher speeds, its ample beam and depth make this a good safe boat. In test runs with the boat powered with a Mercury 10 and carrying a 270 pound man, Polly Wog has hit 34 mph.

In building, try hard to secure close, even joints and use hardwoods such as oak or hard grained Douglas fir for framing, for greater durability. After securing items shown in materials list, draw full-size paper patterns of all frames, including stem and transom. Lay these patterns on your lumber and prick full outlines through to the wood. Then saw to shape. Saw transom from  $\frac{3}{8}$  in. plywood and secure it to a  $\frac{3}{4}$  in. oak frame as shown with a resin glue (such as Weldwood) and 1 in. #8 fh (flathead) screws. After making frames, fasten each joint with two  $\frac{3}{16}$  x 2 in. rh. (roundhead) stove bolts, with washers each side of bolt. Then joint stem together as shown and fasten with resin glue and two  $\frac{1}{4}$  x 4 $\frac{1}{2}$  in. carriage bolts.

Saw the building form from a 2 x 8 x 10 ft. plank and mount it atop legs similar to a sawhorse at a convenient working height. To hold transom and stem in alignment, nail 1 x 2 in. boards to fore and aft parts of form and floor, and, if possible, nail form to floor. After cutting notches for frames in the form, mount frames in their respective positions. Fasten keelson in position to transom, frames and stem with two 2 in. # 9 fh screws to each joint, first drilling lead

**USES:** A medium weight, easily handled outboard utility runabout, with utmost accommodations possible for its length. May be carried by lightweight high-speed trailers. Power with 5 to 20 hp outboard motor.

**LENGTH:** 11 ft. 6 in. overall (measured from transom C. L. to stem).

**BEAM:** 56 in.

**DEPTH FORWARD:** 24 in.

**WEIGHT COMPLETE:** 175 lbs.

**SEATING CAPACITY:** 4 persons smooth water, 2 persons rough water.

**CONSTRUCTION:** Bottom convex built for speed and maneuverability, non-tripping chines built in bottom. Plywood  $\frac{1}{4}$ " over a longitudinally stressed frame. Absence of compound permits easy planking with standard widths and lengths of plywood.

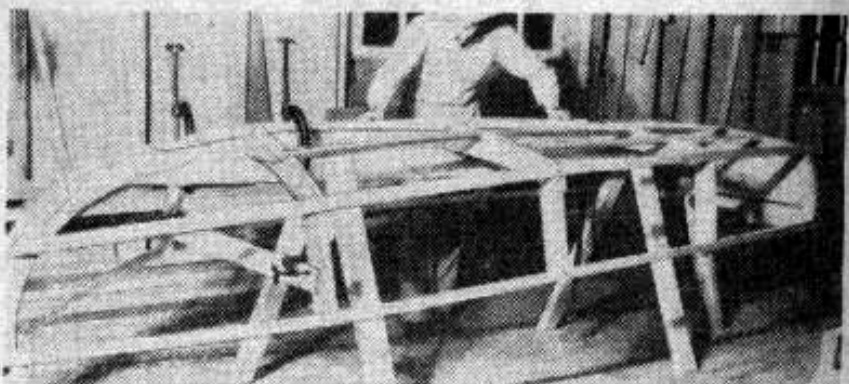
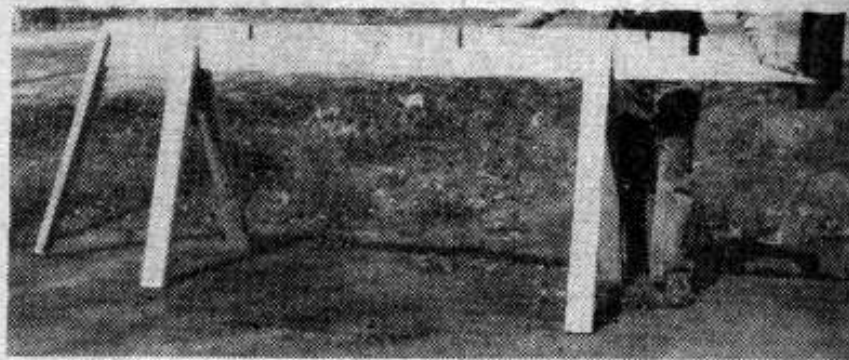

Top, form upon which Polly Wog is built. Below, the framework details of the boat before planking.

holes, countersinking for screwheads and "soaping" screw threads with beeswax. Make sure stem and transom are in perfect alignment. Then notch all the way through transom for chines,



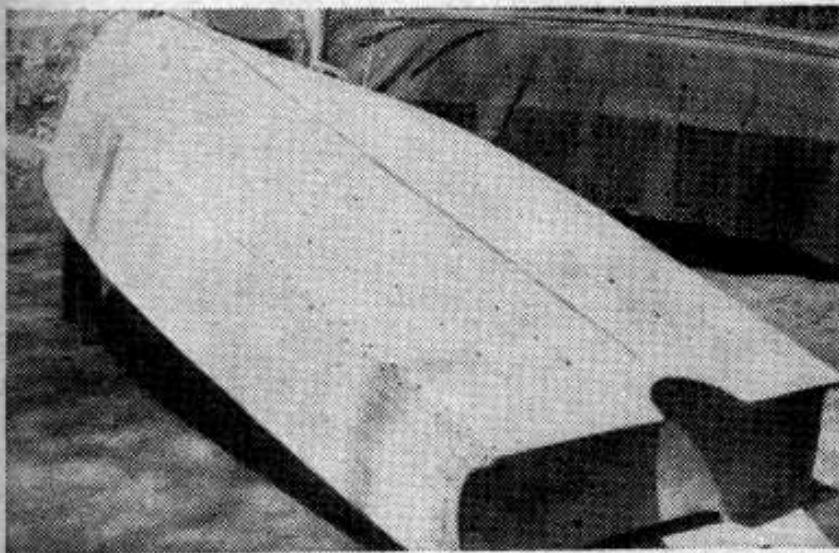
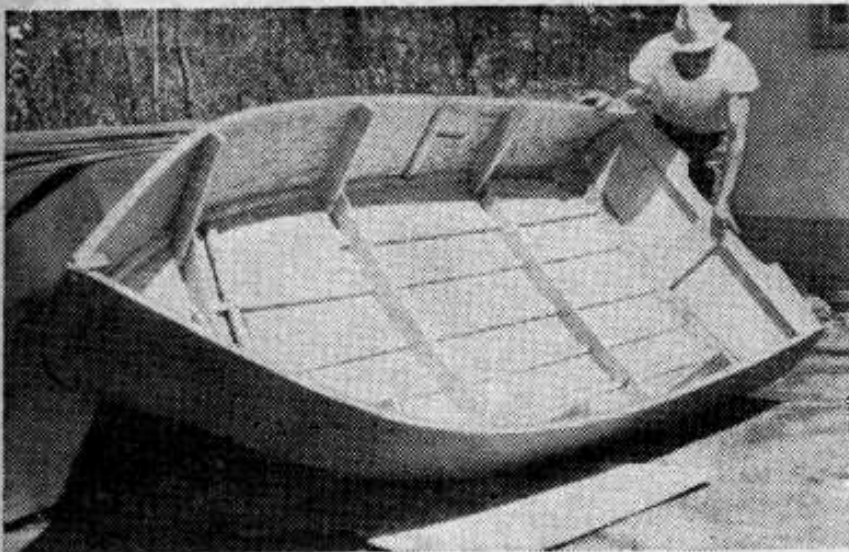

Top, inside is planked and ready to receive beams and carlins. Bottom, bottom view of planked hull.

and with 6 in. of chines projecting aft of transom, fasten both chines in place simultaneously to prevent wringing framework out of shape; use one 2 in. #9 fh screw to each joint. Bevel ends of chines to fit stem and fasten similarly. Now fasten clamps in place as you did the chines and notch bilge battens flush into bottom

MATERIALS LIST—POLLY WOG

Exterior Plywood Required

- 1 pc. 3/8"x4'x8' fir Seats, flooring, transom
  - 1 pc. 1/4"x4'x8' mahogany Decking
  - 2 pcs. 1/4"x4'x14' fir Planking
- (One piece makes one side and one bottom pc.)

Other Lumber Required (Use oak if possible):

- 2 pcs. 3/4"x1 5/8"x12' Chines
- 2 pcs. 3/4"x1 1/4"x12' Clamps
- 4 pcs. 3/4"x1 1/8"x10' Battens
- 2 pcs. 3/4"x1 1/4"x12' Moldings
- 1 pc. 3/4"x3"x10' Keelson
- 1 pc. 5/8"x1 1/8"x10' Keel (outer)
- 1 pc. 3/4"x9 3/4"x10' Frames and transom frame
- 1 pc. 3/4"x7 3/4"x4' Deck beam
- 4 pcs. 3/4"x2"x3' Deck battens
- 4 pcs. 3/4"x1 3/4"x54" Seat supports
- 4 pcs. 3/4"x1 3/4"x18" Seat risers
- 2 pcs. 5/8"x1 1/8"x10' Carlins
- 1 pc. 1 3/4"x7"x24" Stem
- 1 pc. 1 3/4"x6"x30" Stem
- 1 pc. 2"x8"x10" any rough lumber Form

Fastenings Required:

- 2 gross 3/4" #6 fh brass screws Decking
  - 5 gross 3/4" #7 fh screws Planking
  - 3 doz. 1" #8 fh screws Transom, frame
  - 1 gross 1 3/4" #8 fh screws Moldings, keel
  - 3 doz. 2" #9 fh screws Chines, clamps
- 1 qt. resin glue, 1 pt. Kuhl's aviation glue, 1 lb. 1" galvanized nails (planking to clamp)

frames as shown, measuring and positioning battens equi-distant between keelson and chines, and fastening batts with one 1 3/4 in. #8 fh screw to each joint.

Next trim and fair framework so plywood to be applied will lie evenly at all points. In gluing, a hard-setting resin

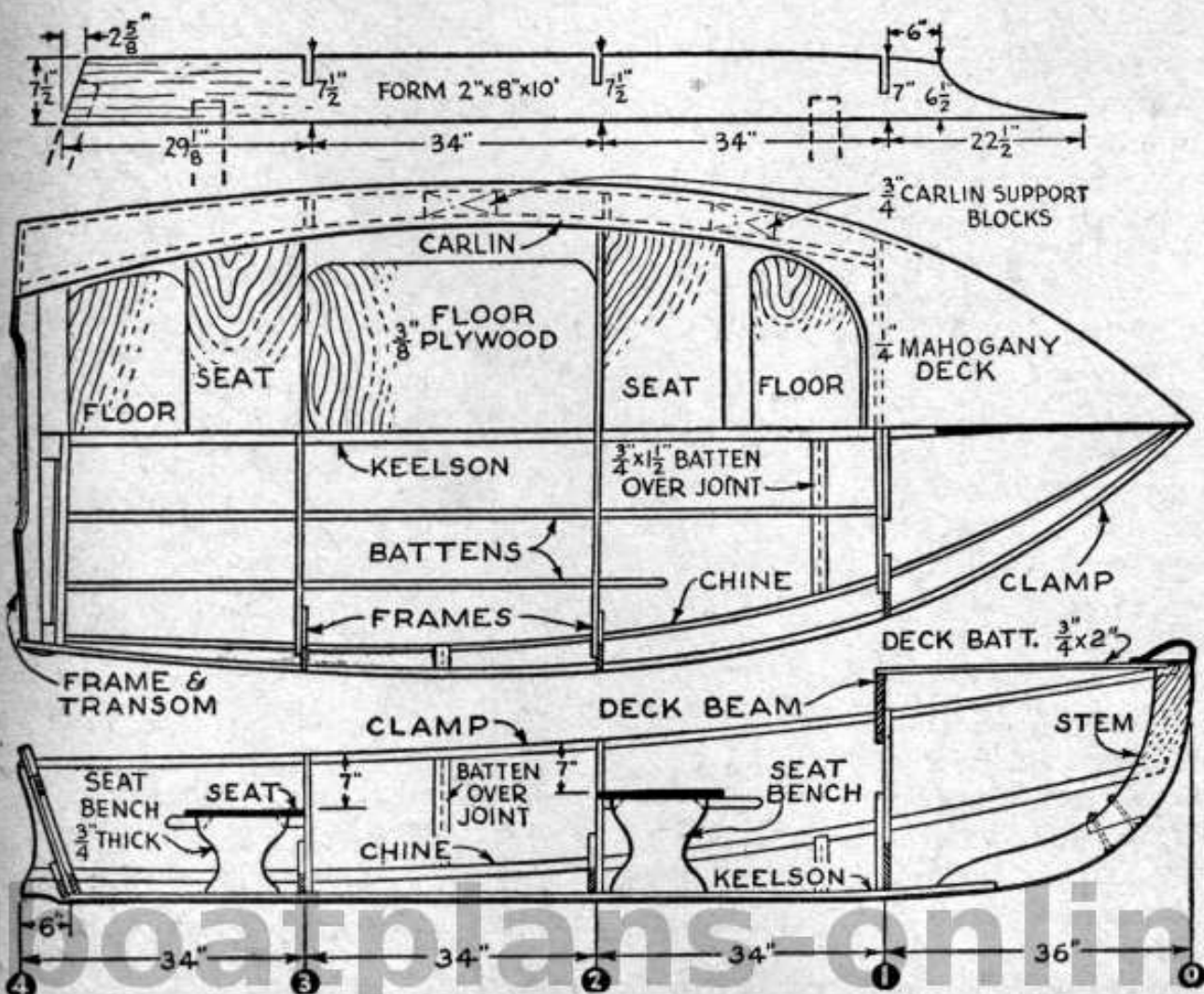
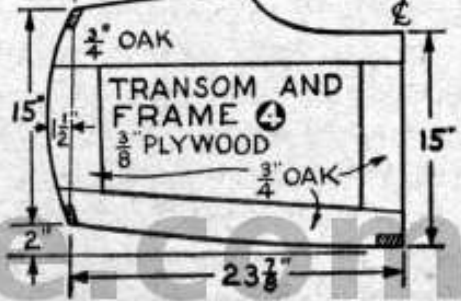
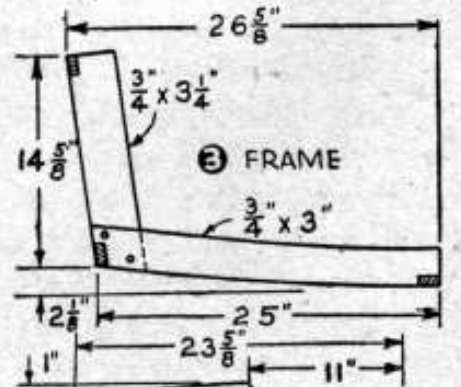
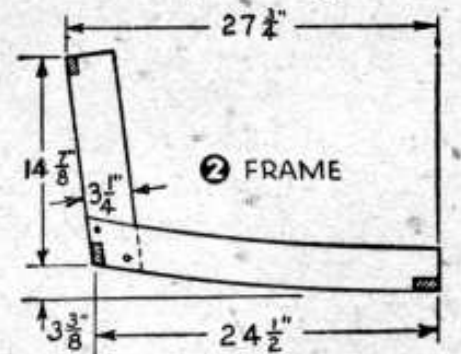
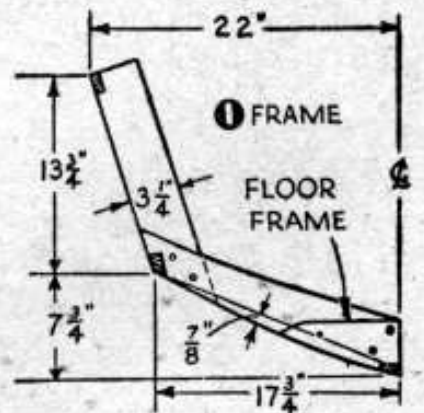



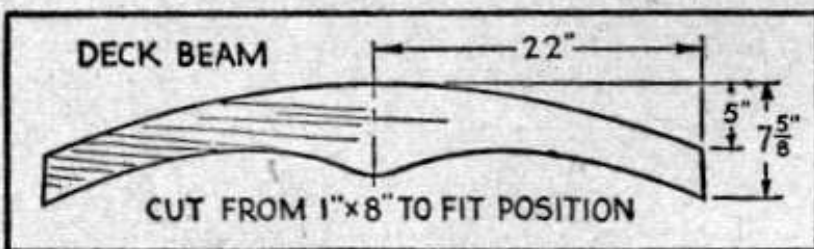
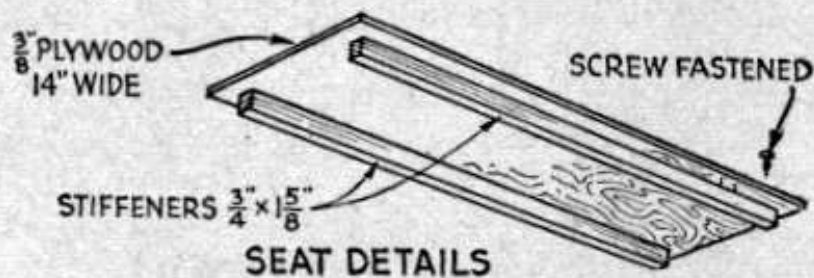
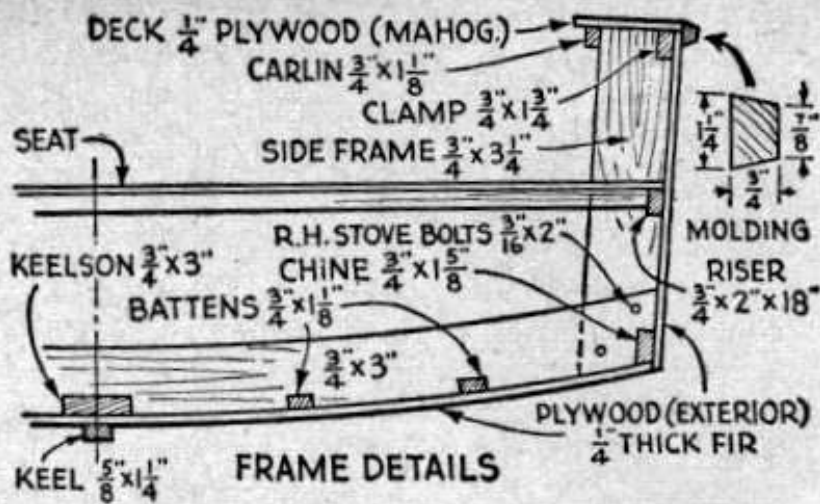

glue will be used for the bottom and an elastic aviation glue or bedding composition (such as Kuhl's) will be used in the side chine joint. Lay a piece of plywood in position and mark and cut bottom planking to shape leaving about 6 in. of plywood to extend over transom. Then coat chines, transom and keel with resin glue and clamp plywood in position. For the curved fore ends of plywood adjacent to stem, pour hot water from a tea kettle on both sides of plywood and, when wood is well-saturated and quite warm, clamp in place and it will bend easily. Fasten planking at all points with  $\frac{3}{4}$  in. #7 fh screws spaced about 2 in. apart, and fasten opposite bottom piece of plywood in the same way.

For a proper joint between side and bottom planking forward at the stem, first trim bottom planking as shown, providing a planking joint that butts together for a distance of 24 in.; remainder of bottom and side plywood pieces simply lap over each other and are trimmed flush. If you don't have an electric saw for cutting this joint directly on the boat, just clamp bottom plywood in position forward, letting it lap over the forward chine; then measure back 24 in. from stem and mark bottom plywood so it is evenly divided on the chine at this point. Finally, remove plank and saw to shape. Coat butt joint and lapped portion of chine with resin glue, put shaped bottom plank in place and fasten with  $\frac{3}{4}$  in. #7 fh screws. A shaped plywood bottom piece will serve as a pattern for the opposite side. Trim bottom edges of plywood along chine.

To attach side planking, first clamp a plywood sheet in position to sides, mark it to shape, providing for a butt joint forward while after portion of side planking laps, and remove marked

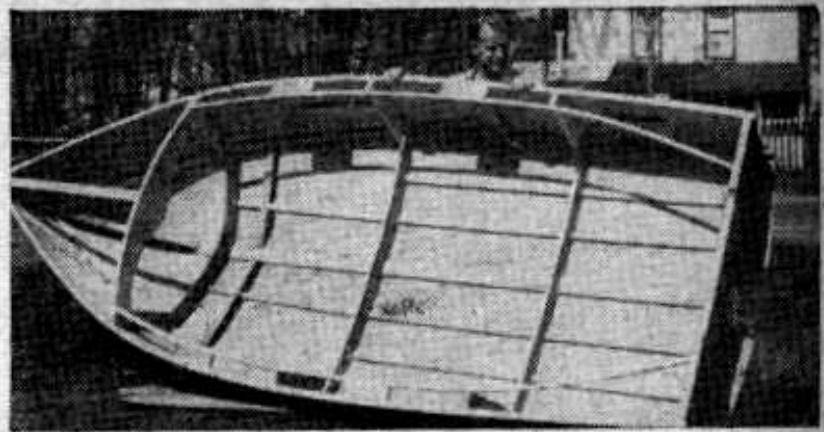

Beams and carlins in place ready for decking

plywood from hull and trim it to shape. Coat butt joint and chine to a point amidships with resin glue and the remainder of chine with aviation glue; then lay cloth strips in place, recoat and fasten shaped plywood side planking in position with  $\frac{3}{4}$  in. #7 fh screws 2 in. apart.

With bottom planked trim edges along chines evenly and then clamp side plywood in position and mark and cut it to shape. Coat chines with aviation glue and clamps with resin glue, then clamp side plywood in position and screw-fasten with  $\frac{3}{4}$  in. #9 fh screws at all points with the exception of the clamps here. Fastening should be with 1 in. nails (or with screws) spaced about 3 in. apart. After hull is planked trim plywood edges evenly and cover exposed edges of plywood along stem with  $\frac{1}{2}$  x  $1\frac{1}{4}$  in. plywood piece, steam bent (see hot water-tea kettle method described previously) and screw-fasten in place; cover keel joint with an outer keel and screw-fasten with  $1\frac{3}{4}$  in. #8 fh screws 8 in. apart.

Now remove hull from form and turn it right-side up. The #1 deck beam is bolted with two  $\frac{3}{16}$  x 2 in. stove bolts and secured to afterside of #1 side frames as shown. Make two  $\frac{3}{8}$  in. plywood seats and seat risers as shown. Screw-fasten risers in place from outside the hull, and

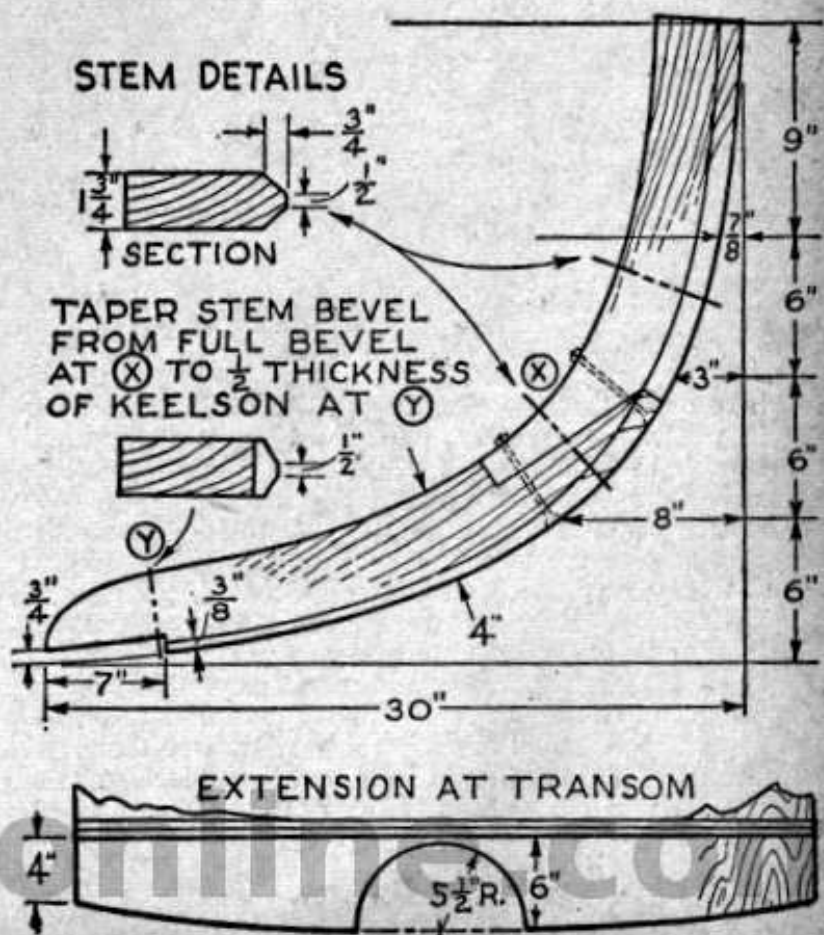

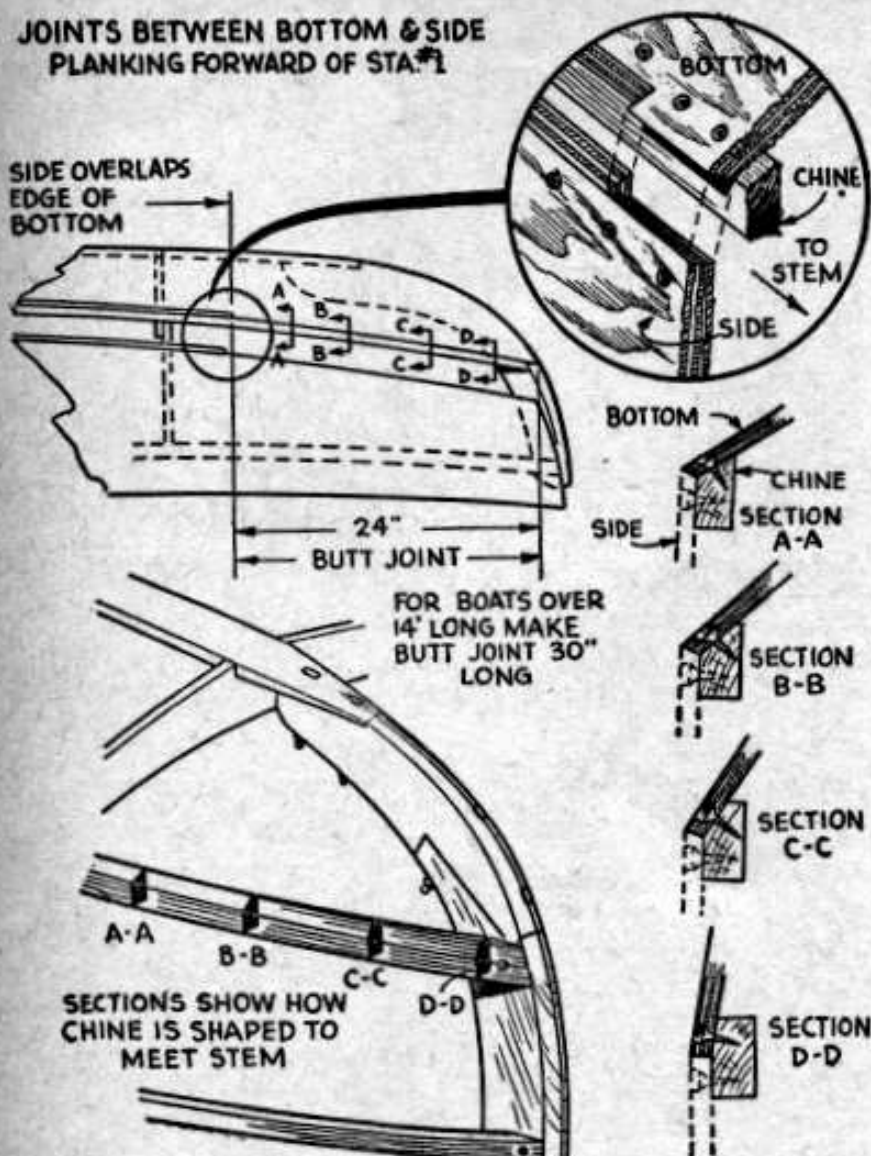

JOINTS BETWEEN BOTTOM & SIDE  
PLANKING FORWARD OF STA. #1

screw-fasten seat to risers. Secure seat benches to keelson. Trim edges of hull evenly and install

carlins by screw-fastening with one  $1\frac{3}{4}$  in. #8 *fh* screw to each joint. Notch a  $\frac{3}{4}$  x 2 in. batten flush into deck beam and stem to secure the center deck joint. For your decking, use  $\frac{1}{4}$  in. waterproof mahogany or fir plywood. Let decking along sides extend over carlins about  $\frac{1}{2}$  in. and fasten decking at all points with  $\frac{3}{4}$  in. #7 *fh* screws spaced about  $2\frac{1}{2}$  in. apart.

Next screw-fasten at sheer edges two  $\frac{3}{4}$  x  $1\frac{1}{4}$  in. moldings to sheer edges of hull with  $1\frac{3}{4}$  in. #8 *fh* screws spaced about 8 in. apart. Paint inside of boat the desired color, then shape  $\frac{3}{8}$  in. plywood flooring pieces to fit position and screw-fasten them in place. For an attractive paint finish, apply 2 coats of flat paint to inside and outside of hull and follow with 2 coats of enamel, using red or green for the bottom, white for sides, and buff or light gray for interior. Fill and coat decking with 3 coats of varnish (allowing ample drying time between coats). Add a bow handle and two lifting handles aft.

● Craft Print No. 152 in enlarged size for building Polly Wog is available at \$1. SPECIAL QUANTITY DISCOUNT! If you order two or more craft prints (this or any other print), you may deduct 25¢ from the regular price of each print. Hence, for two prints, deduct 50¢; three prints, deduct 75¢, etc. Order by print number. To avoid possible loss of coin or currency in the mails, we suggest you remit by check or money order (no C.O.D.'s or stamps) to Craft Print Dept. 212. SCIENCE AND MECHANICS, 450 East Ohio Street, Chicago 11, Illinois. See coupon on page 192. Now available, our new illustrated catalog of "196 Do It Yourself Plans," 10¢. Please allow three to four weeks for delivery.